

MONSTER 821





Index

That's why #welovemonster	2
Timelessicon	5
Streamlinedand sophisticated lines	8
The difference is in the details	11
Monster 821 stealth	12
821 cc of pure fun	18
Extreme riding pleasure	20
Ergonomics for a sportier ride	24
High visibility no matter the conditions	27
Electronic Equipment	28
Fun and control	31
Servicing and maintenance	32
Specifications and equipment	35
Accessories	43
Apparel	53

That's why #welovemonster



A motorcycle that has made history is celebrating its first twenty-five years and those who have shared the journey since the beginning are joining in the celebration and telling their stories. Ever since it came into being, the Monster has represented a turning point for Ducati and the motorcycling world: a one-of-a-kind agile and performance sports bike with a raised set-up and, especially, no fairing.

This bike was in a class of its own, responsible for the birth of the brand-new "sport naked" segment and attracting a large number of followers. Ever since it was presented at the Motorcycle Show in Cologne on 2 October 1992, more than 330,000 Monsters have travelled the roads of the world, giving life to a unique community of enthusiasts, riders who love their motorcycle and know they are part of a big family. A community that, when it came to the launch of the Monster 821, gathered to tell the story of their passion. The passion of a Monster Lover.



Timeless icon

Over the last two decades of its history there has been a continuous and coherent evolution. The sculpted, dynamic lines, attention to detail and the uncompromising streamlined design have made it a timeless icon. The Monster 821 is inspired by the first 1992 model, the Monster 900, and in tribute to its distinctive style, utilises the fuel tank hook, now in aluminium. The round headlight remains a key feature but is more refined and contemporary on the Monster 821.



Streamlined and sophisticated lines

Slender, agile and sleek, yet steadfast in terms of its sportiness and muscle power. The redesigned tank, tail and headlight give the Monster 821 much of its character. The classic Monster proportions and shapes are given a contemporary, modern flavour. In fact, while a Monster is recognisable at first glance, the Monster 821 benefits from original styling solutions. Updates are both aesthetic and functional, since riding pleasure knows no compromise.





The difference is in the details

A streamlined design and attention to detail means that every technical element contributes to the style of this quintessential naked sports bike. From the choice of materials and finishes to the separate rider/passenger pegs; from the colour TFT display with gear position and fuel level indicator to the well-finished, modern silencer. The Monster 821 harmoniously blends design, advanced technology and attention to detail, in both its mechanical and aesthetic details as well as its innovative riding assist solutions. The Ducati Quick Shift (DQS) Up & Down, as standard on the stealth version, Ducati Safety Pack (9.1 MP ABS and Ducati Traction Control, both adjustable), Riding Modes and Power Modes all bring technology and safety for an outstanding riding experience.



Monster 821 stealth

The top-of-line Monster 821 is represented by the stealth version. A matte black livery, dedicated graphics and top fairing give this standout naked Ducati a unique personality, while the adjustable fork and Ducati Quick Shift (DQS) Up/Down, both standard equipment, make it even more effective on the road. The Monster 821 stealth is also fitted out with ABS 9.1 MP, Ducati Traction Control (DTC), both adjustable on several levels, an LED parking light and taillight, an under-seat USB port, passenger seat cover and colour TFT display.





821 cc of pure fun

The desmodromic, twin-cylinder, 821 cc 11° Testastretta engine is full of character while being smooth and powerful and offering excellent handling poise. The 109 horsepower at 9,250 rpm is sure to thrill. The extremely flat torque curve makes the engine particularly enjoyable in any situation; plenty of torque is available even at low rpm, preventing the need to constantly shift gears. The engine of the Monster 821 meets Euro 4 standards without loss of performance, character and, needless to say, sound quality. The exciting engine roar remains a key element of the Monster DNA and clearly defines the 821's bold personality.





Extreme riding pleasure

Torque. Power. Weight. Chassis design. These are the ingredients blended to perfection in the Monster 821 for a pleasurable riding experience, providing amazing handling and agility. The trellis frame has distinguished the Monster bike ever since the first version was introduced in 1992. In the Monster 821, the compact front structure is directly attached to the cylinder heads and this provides optimised lightness and rigidity in addition to giving the 821 its unique and unmistakable design. With its compact wheelbase, refined suspensions and limited weight, the Monster 821 rides easily, lightly and intuitively while also scoring high on precise and dynamic performance. The Monster 821 is extremely balanced and versatile. While able to indulge the newcomers to the Monster world, it also appeals to expert riders thanks to the bike's effective and sporty driving performance on the road.

Ergonomics for a sportier ride

Comfort and control. In other words, giving the rider the conditions with which to exploit the motorcycle's full potential. The Monster 821 is ergonomically designed to have everything within comfortable reach: the wide bars provide excellent control of the motorcycle and the seat can be adjusted to two positions (785- or 810-mm height) for a good positioning of the feet on the ground. Controls, levers and foot pegs are all in the right place so the rider can focus on the ride alone. The shape of the tank improves the rider triangle, and the rider and passenger pegs are now attached to separate mounts for better ergonomics and a sportier look. All in order to maximise riding pleasure.





High visibility no matter the conditions

The front light assembly of the Monster 821 combines different technical solutions to ensure the utmost efficiency and safety. In fact, the LED position light, featuring the typical horseshoe shape of Ducati naked bikes, ensures the motorcycle is perfectly visible in any condition. The main lighting comes from a powerful halogen spot lamp. LEDs are also used for the rear light assembly, for ultimate visibility.



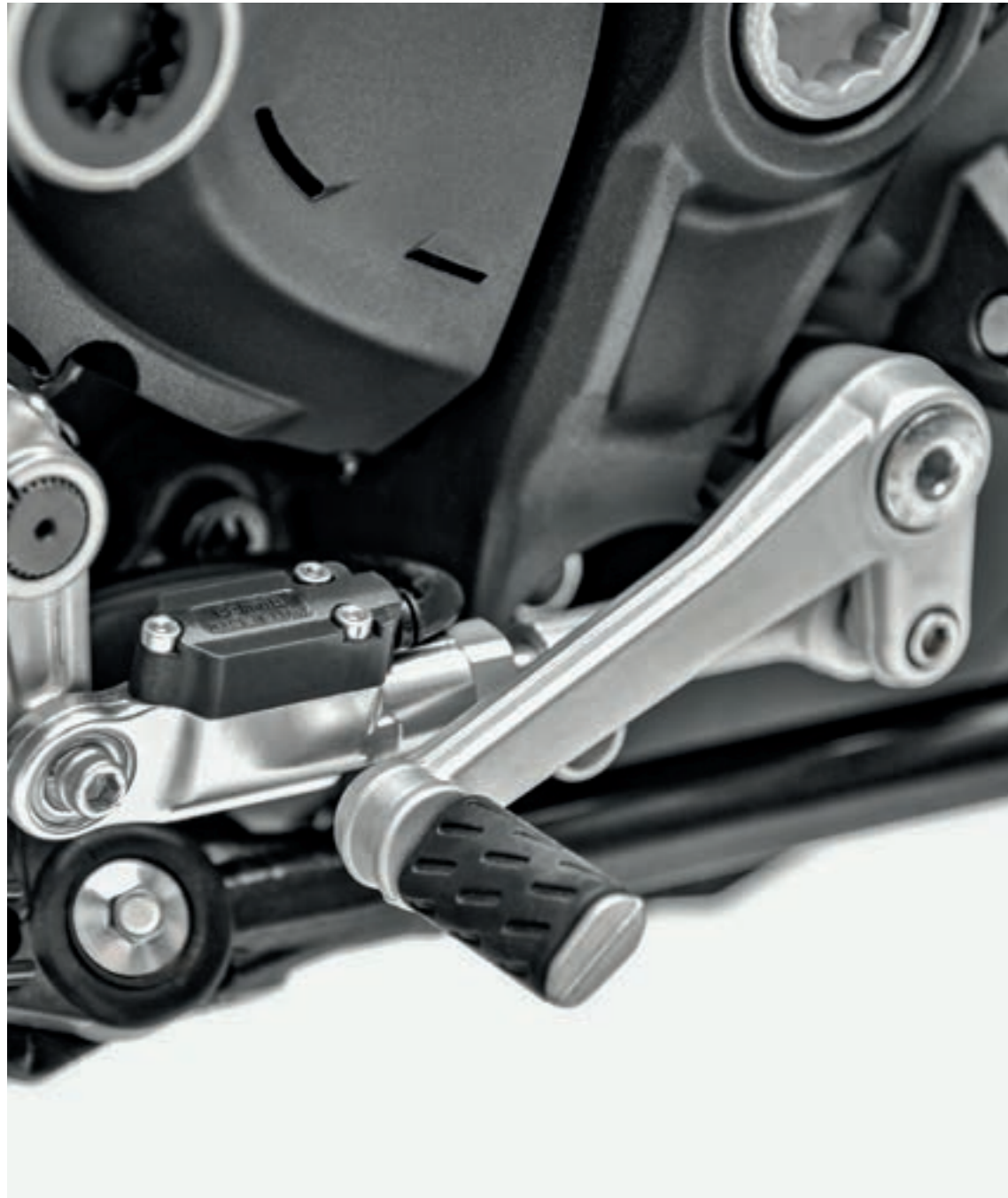

Electronic Equipment

Performance, speed, comfort, safety and a high-level electronics package that allows the rider to focus solely on the ride. The Monster 821 benefits from Ducati racing technology and enjoys what was, until recently, a privilege reserved solely to superbikes. Thanks to the Ride by Wire system, the three Power Modes modify the character, performance and delivery of the twin-cylinder 11° Testastretta engine, adapting to the road conditions and the rider's individual preferences. In addition, standard equipment includes the Ducati Safety Pack, which guarantees maximum riding safety with 9.1 MP ABS and Ducati Traction Control (DTC), both of which are multi-level. The Power Modes and Ducati Safety Pack are integrated into three predefined Riding Modes (Sport, Touring and Urban), but can also be adjusted independently. The Ducati Quick Shift Up/Down is provided as standard on the stealth version and enables the rider to shift up or down quickly without using the clutch.





Fun and control

Enjoy the constant feeling of unique precision and the sense of absolute control. The Monster 821 offers a riding experience that is truly unparalleled, with its stylish chassis, complete electronic package and an engine that combines power and handling. The steel trellis frame ensures Ducati-style riding precision, while the twin-cylinder 11° Testastretta engine offers a generous torque (8.8 kgm at 7,750 rpm) and the power to satisfy even the discerning rider. The Brembo braking system with monoblock calipers is top of the line. Each component contributes to providing control and riding pleasure. For the less-experienced rider, it is intuitive; for riders who want the best, it is spirited and effective. The Monster 821 is the perfect fit for those who love the “pure” riding experience that only a naked sports bike can provide and the charisma of a Ducati motorcycle.

Servicing and maintenance

Safety as standard

The continuous work that Ducati carries out in terms of design, research and development serves to ensure cutting-edge bikes characterised by maximum active safety levels. A commitment that involves the definition of increasingly advanced technological systems to increase the rider's level of control, such as the Ducati Safety Pack (DSP) that, for the Monster 821, includes 9.1 MP ABS and Ducati Traction Control (DTC). Equipment that optimises the bike's dynamic performance in both braking and acceleration and that offers numerous levels of adjustment with three different intervention levels for the ABS and eight for the traction control.

More value to your passion

With Ever Red, the quality and reliability of the Ducati brand remain your inseparable travelling companions over time. Ever Red is the exclusive Ducati warranty extension programme. With its activation you can continue to feel protected for 12 or 24 months beyond the expiration of the Ducati Warranty (24 months). Ever Red includes roadside assistance for the entire coverage period and no mileage limits. In this way you can ride for all the kilometres you want, even abroad, enjoying your Ducati without any worries.

To find out if the Ever Red extension is available in your country and for further information contact your Ducati dealer or visit ducati.com.

Endless excitement

In designing each bike, Ducati constantly strives to ensure maximum reliability while reducing service costs. A commitment that has seen the intervals for the main Desmo Service, in which valve clearance is checked and adjusted if necessary, to be extended to 30,000 km for the Monster 821. Even the simplest of checks, such as the Oil Service, are extended to 15,000 km or 12 months.

A considerable interval for such high-performance engines, which only confirms the high quality standards adopted in terms of material selection and R&D processes. Ducati continuously invests in the technical training of its dealers.

The specific skills offered by the official Ducati Service network ensure that all those operations needed to keep every Ducati in perfect condition are thoroughly executed, while advanced equipment such as the Ducati Diagnosis System allows the software on each Ducati to be updated with the latest releases, ensuring that the electronics continue to perform at the maximum level.

Always by your side

One of Ducati's main goals is to offer every Ducatista the chance to enjoy unlimited and safe travel all over the world. To achieve this aim, Ducati offers a "fast delivery" original spares service, with delivery in 24/48 hours across 85% of the areas in which it operates. With a distribution network that covers more than 86 countries, thanks to 718 official Dealers and Service Points*, choosing a Ducati means you can travel worry-free and in total freedom, wherever the road may take you, and count on capillary support that ensures Ducati quality and professionalism is always close at hand.

718 Authorised dealers and service points

86 World countries

*Information updated as of July 2019



Ever Red
Extended Warranty



*Equal to 18,000 miles.





Specifications and equipment

MONSTER 821

Dimensions

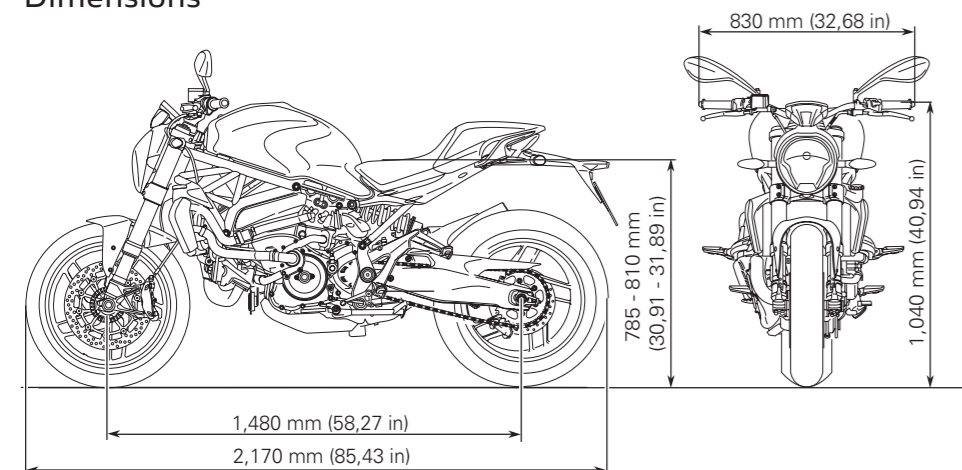

Power and torque

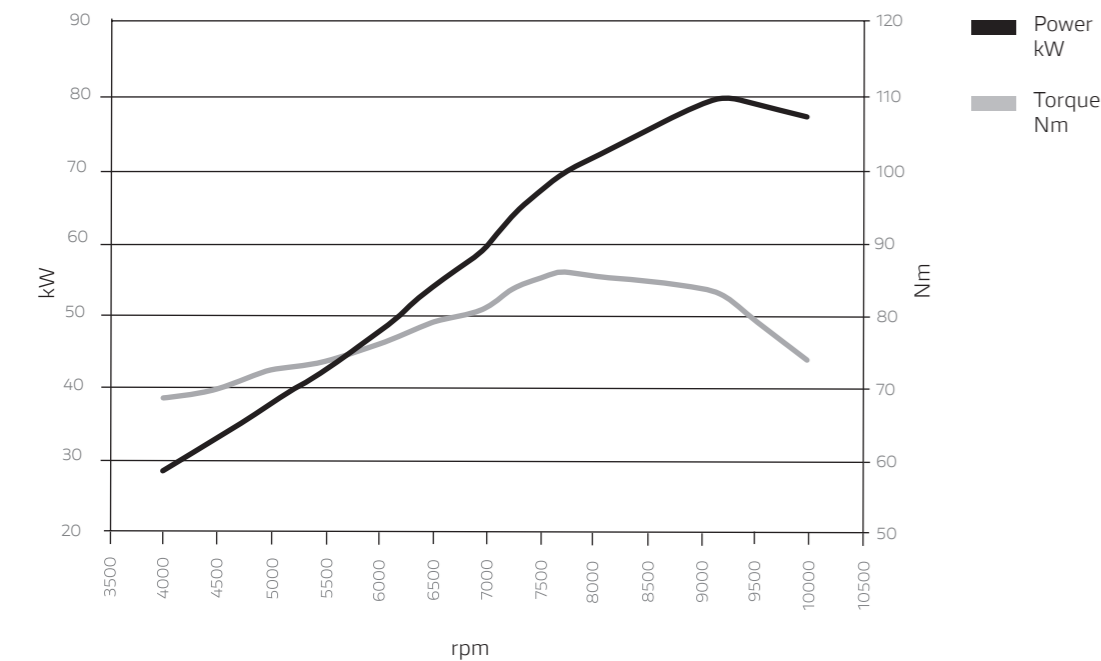

Engine

Engine Testastretta 11°, L-twin cylinder, Desmodromic distribution, four valves per cylinder, liquid-cooled

Displacement 821 cc

Bore x stroke 88 x 67.5 mm

Compression ratio 12.8:1

Power 109 hp (80 kW) @ 9,250 rpm

Torque 8.8 kgm (64 lb-ft, 86 Nm) @ 7,750 rpm

Fuel injection Electronic injection, Ø 53 mm throttle body with full Ride by Wire system

Exhaust Lightweight 2-1 system, 2 lambda probes, stainless steel muffler and aluminium end cap

Transmission

Gearbox 6 speed

Primary drive Straight cut gears, Ratio 1.85:1

Ratios 1=37/15, 2=30/17, 3=28/20, 4=26/22, 5=24/23, 6=23/24

Final drive Chain transmission; front sprocket Z15, rear sprocket Z46

Transmission

Clutch Slipper and self-servo wet multiplate clutch with mechanical control

Chassis

Frame Tubular steel Trellis frame attached to cylinder heads

Front suspension USD Ø 43 mm fork

Front wheel 10-spoke light alloy, 3.5" x 17"

Front tyre 120/70 ZR17 Pirelli Diablo Rosso III

Rear suspension Progressive linkage with adjustable monoshock, Double-sided aluminium swingarm

Rear wheel 10-spoke light alloy, 5.5" x 17"

Rear tyre 180/55 ZR17 Pirelli Diablo Rosso III

Wheel travel (front/rear) 130 mm (5.12 in) - 140 mm (5.50 in)

Front brake 2 x Ø 320 mm semi-floating discs, radially mounted Brembo M4-32 monobloc 4-piston callipers, ABS

Rear brake Ø 245 mm disc, 2-piston floating calliper, ABS

Chassis

Instrumentation TFT colour display

Dimensions and weight

Dry weight 180,5 kg (398 lb)

Weight in running order 206 kg (454 lb)

Seat height Adjustable: 785 - 810 mm (30.9 - 31.9 in)

Wheelbase 1,480 mm (58.3 in)

Rake 24.3°

Front wheel trail 93.2 mm

Fuel tank capacity 16.5 l (4.4 US gal)

Number of seats 2

Safety and technical equipment

Riding Modes, Power Modes, Ducati Safety Pack (ABS + Ducati Traction Control DTC)

Standard equipment

LED position light and tail light, Under-seat USB socket, Passenger seat cover

Ready for

Ducati Quickshift up & down (DQS), Anti-theft system, Ducati Data Analyzer (DDA)

Warranty

Warranty 24 months, unlimited mileage

Maintenance

Maintenance service intervals 15,000 km / 12 months

Valve clearance check 30,000 km (Desmo Service)

Emissions and consumption*

Standard Euro 4

CO₂ Emissions 125 g/km

Consumption 5.3 l/100 km



Equal to 18,000 miles

Kilometers refer to the first Desmo Service, i.e. when the valve clearance is checked and adjusted if necessary.

A 35 kW restricted power version of the Monster 821 is available for restricted license holders. Please contact your dealer for information on availability.

* Only for countries where Euro 4 standard applies.

MONSTER 821 STEALTH



Monster 821



Monster 821 stealth



1 Headlight Fairing

3 Monster 821 stealth livery

2 Adjustable fork

4 Ducati Quickshift up & down

MONSTER 821

Ducati Red



MONSTER 821 STEALTH

Livrea stealth



* Please contact your dealer for information on availability



Accessories



1



2



3

1 Carbon fibre racing silencers



2 Aluminium rear-view mirror



3 Carbon fibre rear mudguard



 This product is designed exclusively for race bikes ridden on a closed racetrack. Its use on public roads is forbidden by law.



1 Carbon instrument cover



2 Tank pocket bag



3 Pair of LED turn indicators



4 Billet aluminium handlebar balancing weights



5 Carbon heat guard

Apparel



Outdoor C-2
Fabric jacket

Dark Rider V2
Full-face helmet

Peak V3
Full-face helmet

Speed 3
Fabric jacket

Company C3
Leather jacket

Company C1
Fabric-leather gloves

Ducati Apparel Collection
designed by
Drudi Performance





Ducati 77
Leather jacket

Ducati 77
Full-face helmet

77
T-shirt

Company C3
Technical jeans



Ducati 77
Leather jacket

Ducati 77
Full-face helmet



Downtown C1
Technical sweatshirt

Company C3
Technical jeans

Downtown C1
Technical short boots



Urban Stripes
Leather jacket





Graphic 77
T-shirt

77
T-shirt

Key to symbols

 This product is designed exclusively for race bikes ridden on a closed racetrack. Its use on public roads is forbidden by law.

 For racing use only. The product marked with this symbol can only be used on competition vehicles. Use outside a competition track of motorcycles equipped with this product is prohibited by law. Verify any further restrictions with the relevant race course. Motorcycles equipped with this accessory are prohibited from operating on public roads.

 This accessory is not approved for road circulation.

 Accessory type-approved for road use.

 Anodized

 Matt

 Tinted

 Dark stealth

 Silver

 Red

 Black

ducati.com

Riding a motorcycle is the most exciting way to enjoy the road, and offering the utmost safety to the motorcyclist is Ducati's commitment. Ducati bikes are increasingly easy to handle, reliable and better equipped to guarantee maximum safety and enhance riding pleasure. Technical clothing is made with more and more advanced materials for adequate protection and increased visibility. The safety of motorcyclists is Ducati's commitment. For more information visit the safety section of the Ducati site (www.ducati.com).

Warning: The photos and technical information in this catalogue may refer to prototypes subject to modifications during production and are purely for illustration and reference purposes, and are therefore not binding on Ducati Motor Holding S.p.A. Sole Shareholder Company - Company subject to the direction and coordination of AUDI AG ("Ducati"). Ducati cannot be held responsible for any print and/or translation errors. This catalogue is transnational and therefore some products may not be available and/or their features may vary in accordance with local laws. Not all colours and versions are available in each country. Ducati reserves the right to make changes and improvements to any product without obligation of prior notice or to make such changes to products already sold. Further characteristics of the products are contained in the pertinent owner's manuals. The products represented are not definitive versions and are therefore subject to significant changes at Ducati's discretion without prior notice. The photographs published in this catalogue show only professional riders under controlled street conditions. Do not attempt to imitate such riding behaviour as it could be dangerous for you or other people on the road. This catalogue, including but not limited to the trademarks, logos, texts, images, graphics and table of contents herein, constitute Ducati intellectual property, or in any event Ducati has the right to reproduce it; any reproduction, modification or other whole or partial use of the catalogue or its contents, including publication on the Internet without the prior written consent of Ducati, is prohibited.

Actual fuel consumption may vary based on many factors, including but not limited to riding style, maintenance performed, weather conditions, surface characteristics, tyre pressure, load, weight of the rider and the passenger, accessories.

Ducati indicates the dry weight of the motorcycle excluding battery, lubricants and coolants for liquid-cooled models. The weights in running order are considered with all operating fluids, standard equipment and the fuel tank filled to 90% of its useful capacity (UE regulation no. 168/2013). October 2019.



DUCATI

MONSTER 821

Developed with



Technical



WDW2020
WORLD DUCATI WEEK
17th - 19th July / Misano, Italy
wdw.ducati.com

ducati.com